

MaxMotion

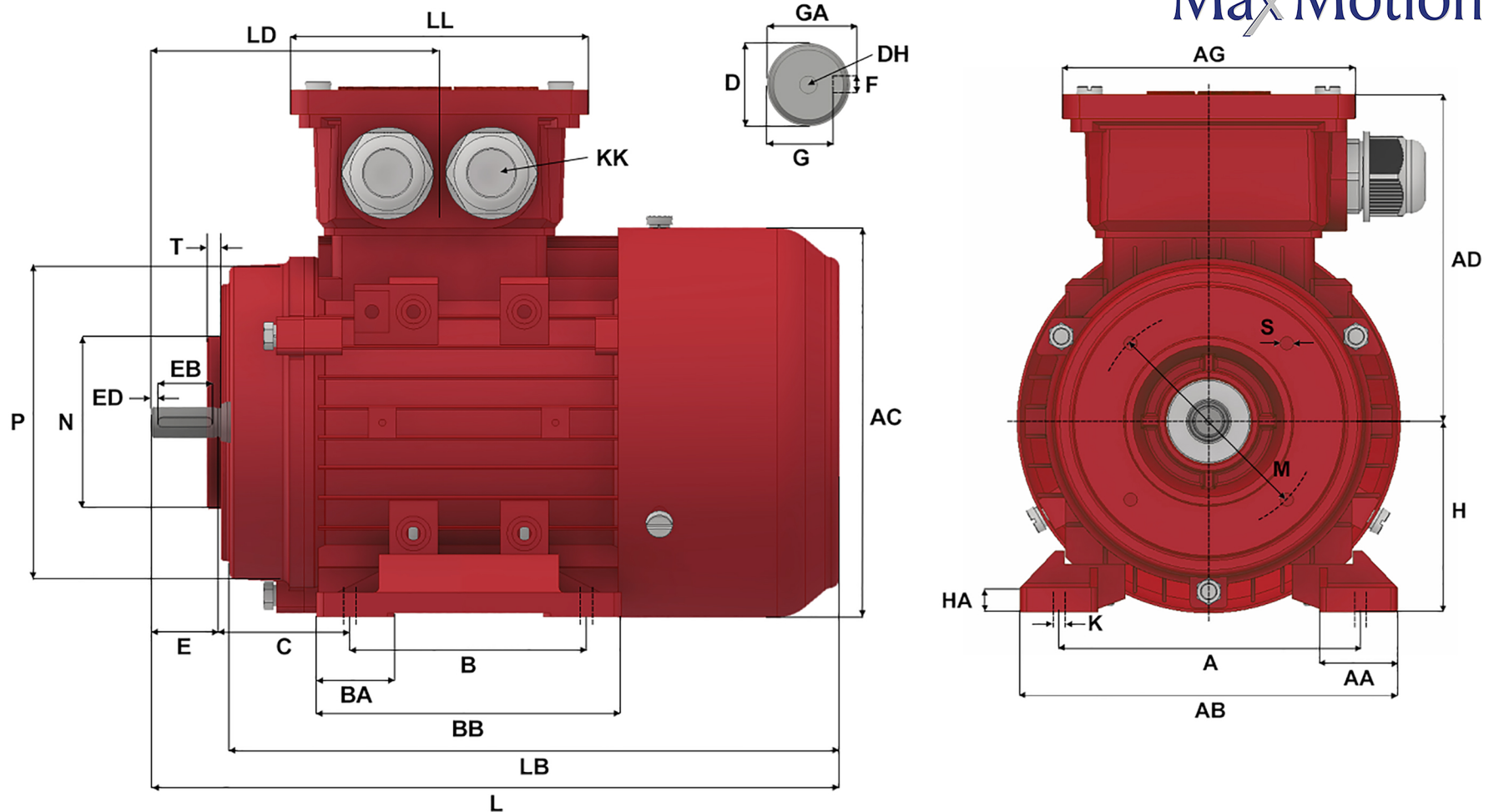

Version: 1JLEM		Revised: 09-11-2019				HP	RPM	FRAME	ENCLOSURE	IJA90L-4-B34A			
Customer is responsible in determining that Max Motion product will fit/perform suitably in the intended application						2	1730	90L	TEFC				
A	B	C	D	E	F	G	H	K	L	M	N	P	
140	125	56	24	50	8	20	90	10 X 14	345	115	95	140	
S	T	AA	AB	AC	AD	AG	BA	BB	DH	EB	ED	GA	
M8	3	37	173	175	138	109	31.5	125	M8 X 19	40	5	27	
HA	KK (1)	KK (2)	KK (3)	LB	LD	LL							
10	M20 X 1.5	3/4" NPT	-	295	136	109							